

■ CONTENTS

CAUTIONS	1-2
SAFETY PRECAUTIONS	3
FEATURES AND FUNCTIONS	4
NAME OF PARTS	5
INTRODUCTION TO SPARE PARTS.....	6-7
INSTALLATION.....	8
REMOTE CONTROLLER OPERATION.....	9
GUIDE TO OPERATION	10-17
CLEANING AND CARE	18-19
TROUBLE SHOOTING.....	20-21
OPERATIONG TIPS	22

■ CAUTIONS

Disposal of the old air conditioner

Before disposing an old air conditioner that goes out of use, please make sure it's inoperative and safe. Unplug the air conditioner in order to avoid the risk of child entrapment.

It must be noticed that air conditioner system contains refrigerants, which require specialized waste disposal. The valuable materials contained in a air conditioner can be recycled. Contact your local waste disposal center for proper disposal of an old air conditioner and contact your local authority or your dealer if you have any question. Please ensure that the pipework of your air conditioner does not get damaged prior to being picked up by the relevant waste disposal center, and contribute to environmental awareness by insisting on an appropriate, anti-pollution method of disposal.

Disposal of the packaging of your new air conditioner

All the packaging materials employed in the package of your new air conditioner may be disposed without any danger to the environment.

The cardboard box may be broken or cut into smaller pieces and given to a waste paper disposal service. The wrapping bag made of polyethylene and the polyethylene foam pads contain no fluorochloric hydrocarbon.

All these valuable materials may be taken to a waste collecting center and used again after adequate recycling.

Consult your local authorities for the name and address of the waste materials collecting centers and waste paper disposal services nearest to your house.

Safety Instructions and Warnings

Before starting the air conditioner, read the information given in the User's Guide carefully. The User's Guide contains very important observations relating to the assembly, operation and maintenance of the air conditioner.

The manufacturer does not accept responsibility for any damages that may arise due to non-observation of the following instruction.

- Damaged air conditioners are not to be put into operation. In case of doubt, consult your supplier.
- Use of the air conditioner is to be carried out in strict compliance with the relative instructions set forth in the User's Guide.
- Installation shall be done by professional people, don't install unit by yourself.

■ CAUTIONS

- For the purpose of safety, the air conditioner must be properly grounded in accordance with specifications.

- Always remember to unplug the air conditioner before opening inlet grill. Never unplug your air conditioner by pulling on the power cord. Always grip plug firmly and pull straight out from the outlet.

- All electrical repairs must be carried out by qualified electricians. Inadequate repairs may result in a major source of danger for the user of the air conditioner.

- Do not damage any parts of the air conditioner that carry refrigerant by piercing or perforating the air conditioner's tubes with sharp or pointed items, crushing or twisting any tubes, or scraping the coatings off the surfaces. If the refrigerant spurts out and gets into eyes, it may result in serious eye injuries.

- Do not obstruct or cover the ventilation grille of the air conditioner. Do not put fingers or any other things into the inlet/outlet and swing louver.

- Do not allow children to play with the air conditioner. In no case should children be allowed to sit on the outdoor unit.

Specifications

- The refrigerating circuit is leak-proof.
- When installation in under ceiling, dial switch "K1" in the PC board to "D" position. When installation in floor console, dial switch to "L" position (Brand new unit is in "D" position).For series 14, 18.

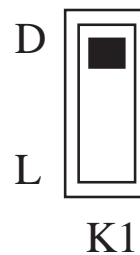

- For series 14,18, the all-pole disconnection connection method should be applied in the power supply.
- For series 24,28,36,42,the breaker of the air conditioner should be all-pole switch;and the distance between its two contacts should be no less 3mm. Such means for disconnection must be incorporation in the fixed wiring.

■ SAFETY PRECAUTIONS

⚠ WARNING!

- For series 14,18, if the power supply cord of this air conditioner is damaged, it must be replaced by the manufacturer its authorized service personnel only.
- For series 24,28,36,42, the breaker of the air conditioner should be all-pole switch; and the distance between its two contacts should be no less 3mm. Such means for disconnection must be incorporation in the fixed wiring.
- Use copper wire only. All the cables shall have got the European authentication certificate.
- For series 14,18, the power supply connects from the indoor side.
For series 24,28,36,42, the power supply connects from the outdoor side. The power cable and connecting cable are self-provided.
- The parameter of connecting cable:
For AC182ACABA, AU182AFABA, (HCFU-18HC03), AC142ACAAA,AU142AFAAA(HCFU-14H03), AC142ACBAA, AU142AFBAA, (HCFU-14H03/R1) H05RN-F 4G 0.75mm², H07RN-F 2x2.0mm².
For AC182ACMBA, AU182AFMBA, (HCFU-18CC03), AC184ACMAA, AU184AFMDA (HCFU-18C13), AC182ACNBA, AU182AFNBA, (HCFU-18CA03/R1), AC142ACMAA, AU142AFMAA(HCFU-14C03), AC142ACNAA,AU142AFNAA,(HCFU-14C03/R1). H07RN-F 3G 2.0mm².
For series 24,28,36,42, H05RN-F 4G 0.75mm². The power cable and connecting cable are self-provided.
- The requirement of the corss section area of the power supply cord:
For series 14,18, H07RN-F 3G 2.5mm².
For series 24,28(Power supply:1PH,220-230V~,50Hz), H07RN-F 3G 4.0mm².
For series 28(Power supply:380-400V,3N~, 50Hz), 36,42, H07RN-F 5G 2.5mm².

⚠ DANGER!

- Do not attempt to install this air conditioner by yourself.
- This unit contains no user-serviceable parts. Always consult authorized service personnel for repairs.
- When moving, consult authorized service personnel for disconnection and installation of the unit.
- Do not become excessively chilled by staying for lengthy periods in the direct cooling airflow.
- Do not insert fingers or objects into the outlet port or intake grills.
- Do not start and stop air conditioner operation by connecting and disconnecting the power supply cord and so on.
- Take care not to damage the power supply cord.
- In the event of a malfunction (burning smell, etc.), stop operation immediately, turn off the circuit breaker, and consult authorized service personnel.

⚠ CAUTION!

- Provide occasional ventilation during use.
- Do not direct air flow at fireplaces or heating apparatuses.
- Do not climb on place objects on the air conditioner.
- Do not hang objects from the indoor unit.
- Do not set flower vases or water containers on top of the air conditioner.
- Do not expose the air conditioner directly to water.
- Do not operate the air conditioner with wet hands.
- Do not pull power supply cord.
- Turn off power source when not using the unit for extended periods.
- Check the condition of the installation stand for damage.
- Do not place animals or plants in the direct path of the air flow.
- Do not drink the water drained from the air conditioner.
- Do not use in applications involving the storage of foods, plants or animals, precision equipment, or art works.
- Do not apply any heavy pressure to radiator fins.
- Operate only with air filters installed.
- Do not block or cover the intake grill and outlet port.
- Ensure that any electronic equipment is at least one metre away from either the indoor or outdoor unit.
- Avoid installing the air conditioner near a fireplace or other heating apparatuses.
- When installing the indoor and outdoor unit, take precautions to prevent access to infants.
- Do not use inflammable gases near the air conditioner.

■ FEATURES AND FUNCTIONS

AUTOMATIC OPERATION

- **COOLING TYPE**

Merely press the ON/OFF button, and the unit will begin automatic operation in the Cooling or dry modes as appropriate, in accordance with the thermostat setting and the actual temperature of the room.

- **HEAT & COOL TYPE**

Merely press the ON/OFF button, and the unit will begin automatic operation in any of the Heating, Cooling and Blow modes as appropriate, in accordance with the thermostat setting and the actual temperature of the room.

SLEEP

- **COOLING TYPE**

When the SLEEP button is pressed during Cooling or Dry mode, the thermostat setting gradually rises during the period of operation. When the set time is reached, the unit automatically turns off.

- **HEAT & COOL TYPE**

When the SLEEP button is pressed during Heating mode, the air conditioner's thermostat setting gradually lowers during the period of operation; When the set time is reached, the unit automatically turns off.

WIRELESS REMOTE CONTROL UNIT

- The WIRELESS REMOTE CONTROL UNIT allows convenient control of air conditioner operation.

MILDEW-RESISTANT FILTER

- The AIR FILTER has been treated to resist mildew growth, thus allowing cleaner use and easier care.

NAME OF PARTS

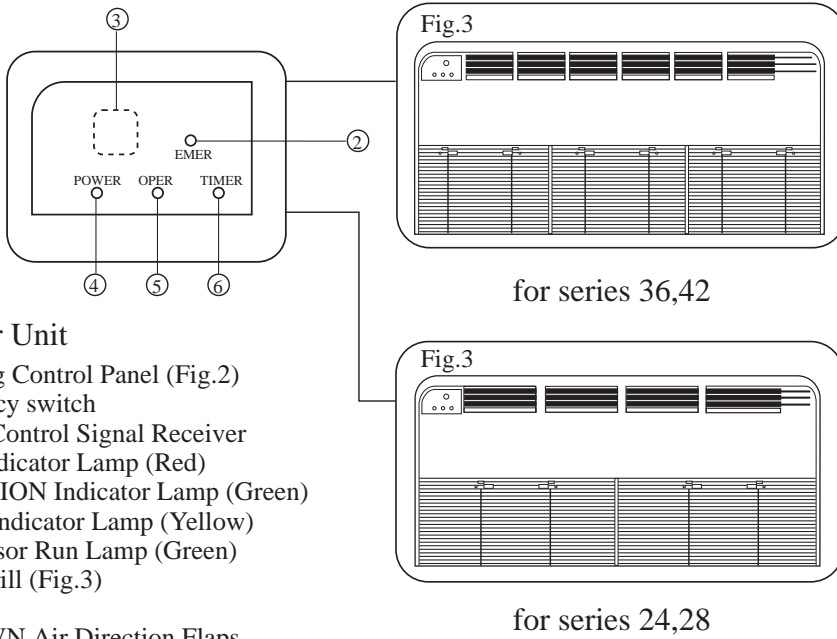
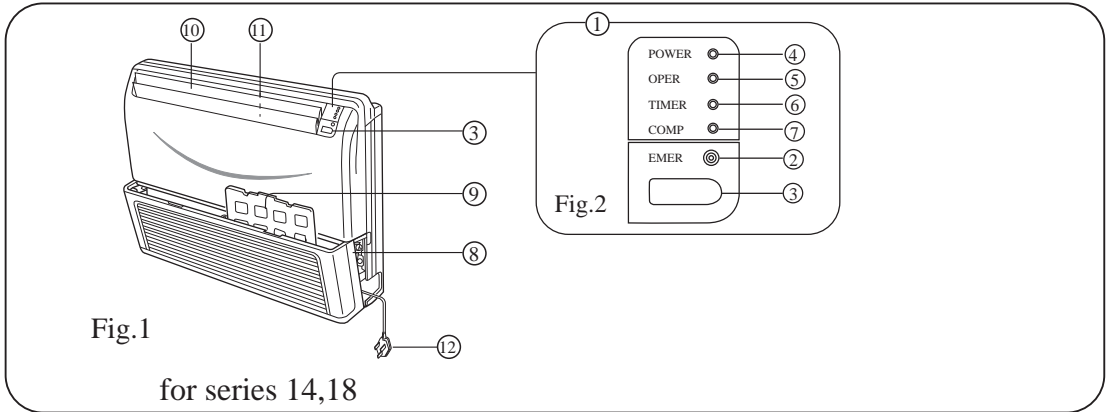
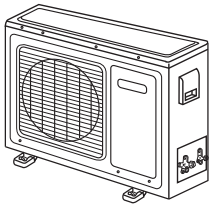
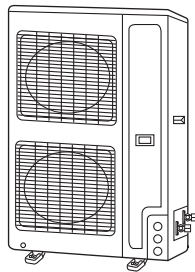

Fig.1 Indoor Unit

- ① Operating Control Panel (Fig.2)
- ② Emergency switch
- ③ Remote Control Signal Receiver
- ④ Power Indicator Lamp (Red)
- ⑤ OPERATION Indicator Lamp (Green)
- ⑥ TIMER Indicator Lamp (Yellow)
- ⑦ Compressor Run Lamp (Green)
- ⑧ Intake Grill (Fig.3)
- ⑨ Air Filter
- ⑩ UP/DOWN Air Direction Flaps
- ⑪ RIGHT/LEFT Air Direction Louvers (behind UP/DOWN Air Direction Flaps)
- ⑫ Power Plug



For series 24,28



For series 36,42

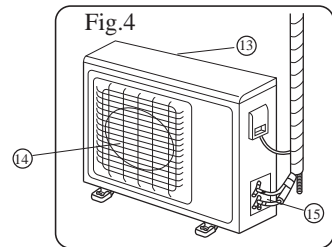

For series 14,18

Fig.4 Outdoor Unit

- ⑬ Intake grill
- ⑭ Outlet grill
- ⑮ Pipe Unit

INTRODUCTION TO SPARE PARTS

Operation

Buttons and display of the remote controller.

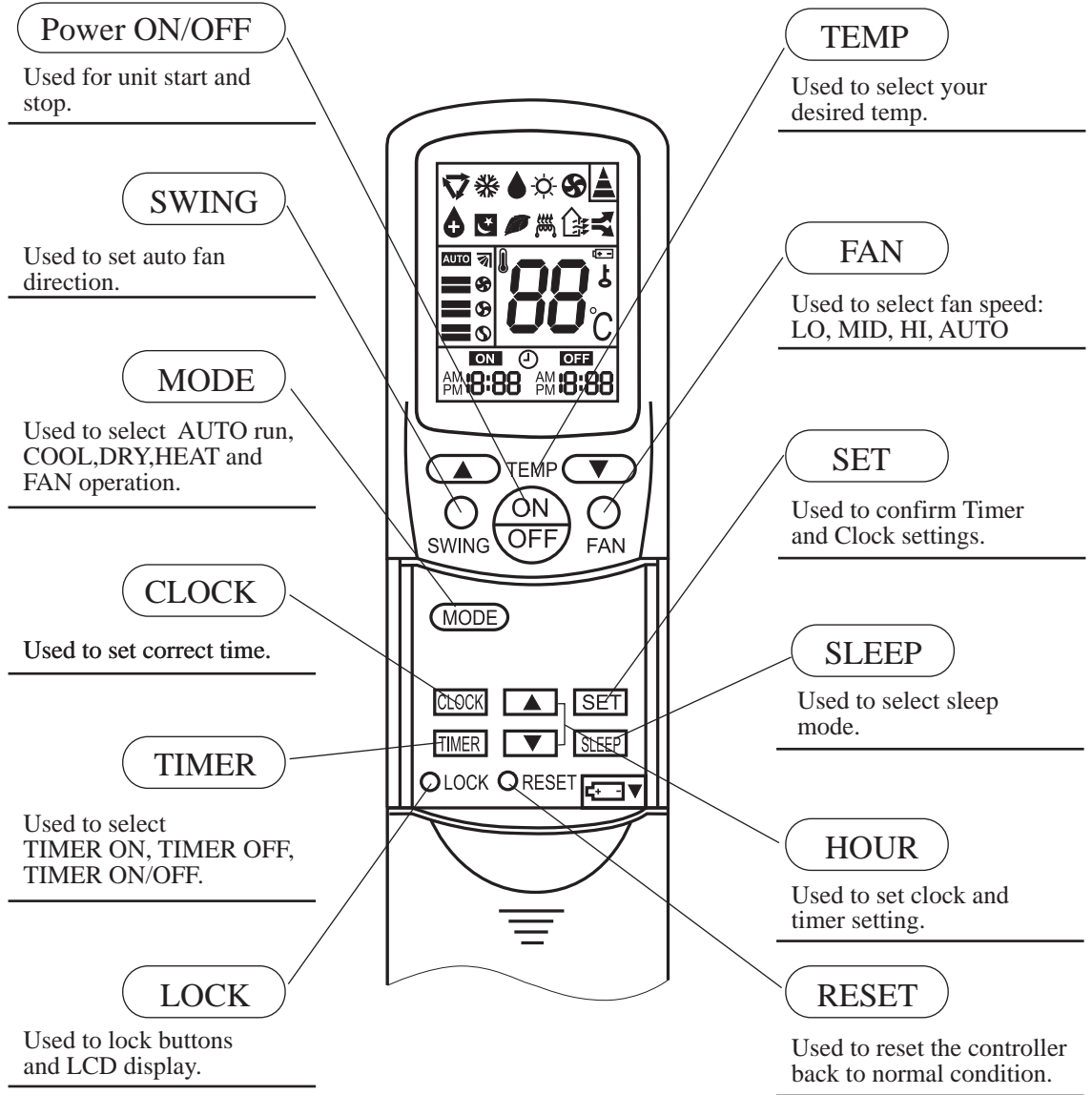

Cautions:

On cooling only unit, heating mode is not available.
 After replacing batteries, press ON/OFF, and display becomes as follows:
 Operation mode: AUTO, Temp: 24°C
 Timer mode: No, Fan speed: AUTO

Note:

1. The above information is the explanation of the displayed information therefore varies with those displayed in actual operation.
2. This type only has the relevant function and display as indicated in the above figure.

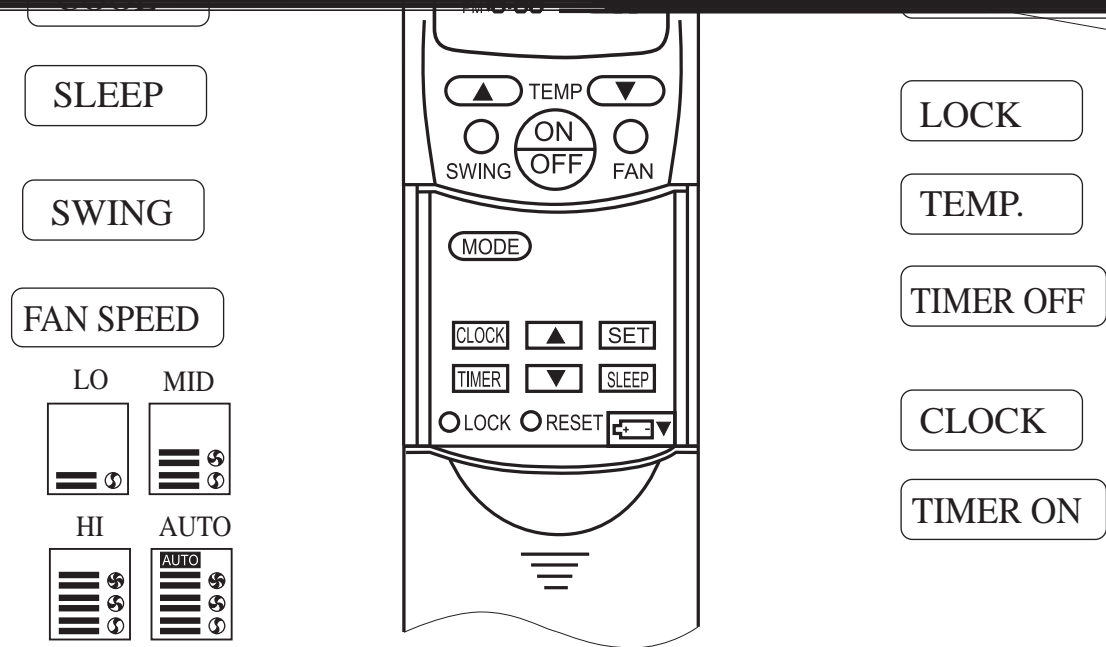

Clock set

When unit is started for the first time and after replacing batteries in remote controller, clock should be adjusted as follows:

Press CLOCK button, "AM" or "PM" flashes.

Press ▲ or ▼ to set correct time. Each press will increase or decrease 1min. If the button is kept depressed, time will change quickly.

After time setting is confirmed, press SET, "AM "and "PM" stop flashing, while clock starts working.

Hints
 After replacing with new batteries, remote controller will conduct self-check, displaying all information on LCD. Then, it will become normal.

■ INSTALLATION

Please ask the dealer or specialist to install, never try by the users themselves. After the installation please be sure of the following conditions.

WARNING !

- **Please call dealer to install the air-conditioner.**
Incorrect installation may cause water leaking, shock and fire hazard.

CAUTION !

- **Air-conditioner can't be installed in the environment with inflammable gases because the inflammable gases near to air-conditioner may cause fire hazard.**
- **Installed electrical-leaking circuit breaker.**
It easily cause electrical shock without circuit breaker.
- **Connect earthing wire.**
Earthing wire should not be connected to the gas pipe, water pipe, lightning rod or phone line, incorrect earthing may cause shock.  Earthing
- **Use discharge pipe correctly to ensure efficient discharge.**
Incorrect pipe use may cause water leaking.

[Location]

- Air-conditioner should be located in well-vented and easily-accessible place.
- Air-conditioner should not be located in the following places:
 - (a) Places with machine oils or other oil vapours.
 - (b) Seaside with high salt content in the air.
 - (c) Near to hot spring with high content of sulfide gases.
 - (d) Area with frequent fluctuation of voltage e.g. factory, etc.
 - (e) In vehicles or ships.
 - (f) Kitchen with heavy oil vapour or humidity.
 - (g) Near to the machine emitting electric-magnetic waves.
 - (h) Places with acid, alkali vapour.
- TV, radio, acoustic appliances etc are at least 1 m far away to the indoor unit, outdoor unit, power

supply wire, connecting wire, pipes, otherwise images may be disturbed or noises be created.

- As required, take measures against heavy snow.

[Wiring]

- Air-conditioner should be equipped with special power supply wire.

[Operating noise]

- Choose the following locations:
 - (a) Capable of supporting air-conditioner weight, don't increase operating noise and vibration.
 - (b) Hot vapour from outdoor unit outlet and operating noise don't disturb neighbour.
- No obstacles around the outdoor unit outlet.

■ REMOTE CONTROLLER OPERATION

Remote controller's operation

- When in use, put the signal transmission head directly to the receiver hole on the indoor unit.
- The distance between the signal transmission head and the receiver hole should be within 7m without any obstacle as well.
- Don't throw the controller, prevent it from being damaged.
- When electronic-started type fluorescent lamp or change-over type fluorescent lamp or wireless telephone is installed in the room, the receiver is apt to be disturbed in receiving the signals so the distance to the indoor unit should be shorter.

Loading of the battery

Load the batteries as illustrated.

2R-03 batteries, resetting key (cylinder)

Remove the battery cover :

Slightly press "▼" and push down the cover.

Load the battery :

Be sure that the loading is in line with the "+" / "-" pole request as illustrated.

Put on the cover again

Confirmation indicator :

In disorderation, reload the batteries or load the new batteries after 5mins.

Note :

Use two new same-typed batteries when loading.

If the remote controller can't run normally or doesn't work at all, use a sharp pointed item to press the reset key.

Hint : Remove the batteries in case unit won't be in usage for a long period.

If there is any display after taking-out just need to press reset key.

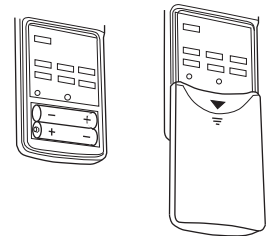
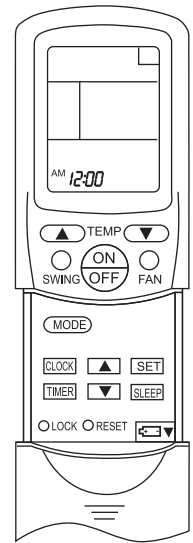

■ GUIDE TO OPERATION

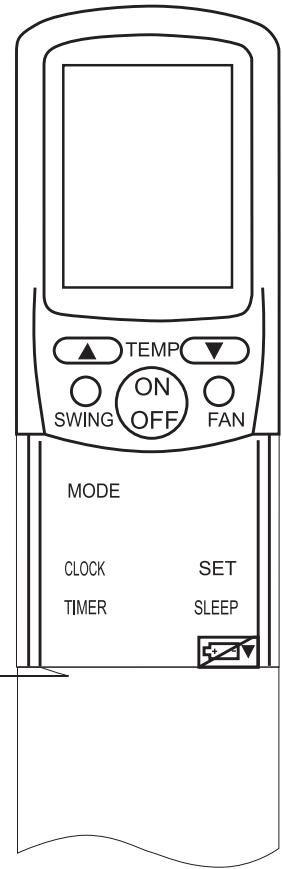

■ GUIDE TO OPERATION

°C

TEMP
ON
SWING OFF FAN

MODE

○ LOCK ○ RESET 

•
•

■ GUIDE TO OPERATION

temp. setting
regardless of FAN setting.

◦

■ GUIDE TO OPERATION

TIMER ON-OFF

(1)After unit start, select your desired operation mode

Operation mode will be displayed on LCD.

Power indicator on indoor unit lights up.

(2)Press TIMER button to change TIMER mode

Every time the button is pressed, display changes as follows:



Select TIMER ON-OFF, "ON" will flash.

(3)Time setting for TIMER ON

Press HOUR button.

▲ Every time the button is pressed, time increases 10min.

If button is kept depressed, time will change quickly.

▼ Every time the button is pressed, time decreases 10min.

If button is kept depressed, time will change quickly. Time will be shown on LCD.

It can be adjusted within 24hours.

AM refers to morning and PM to afternoon.

(4)Time confirming for TIMER ON

After time setting, press TIMER button to confirm.

"ON" stops blinking, While "OFF" starts blinking.

Time displayed: Unit starts at X hour X min.

(5)Time setting for TIMER OFF

Follow the same procedures in "Time setting for TIMER ON".

(6)Time confirming for TIMER OFF

After time setting, press SET button to confirm "OFF" stops flashing.

Time displayed: Unit starts at X hour X min.

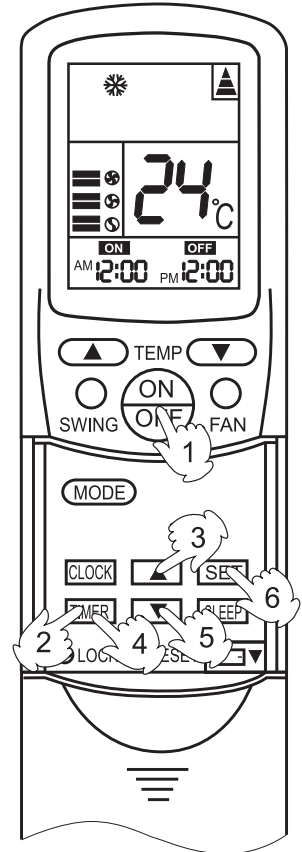

To cancel TIMER mode

■ Just press TIMER button several times until TIMER mode disappears.

■ According to the Time setting sequence of TIMER ON or TIMER OFF, either Start-Stop or Stop-Start can be achieved.

■ GUIDE TO OPERATION

Adjusting up/down air flow direction

- Up/down direction can be adjusted by using the SWING button on the remote controller. Each time pressing this button, the mode changes in the following sequence.

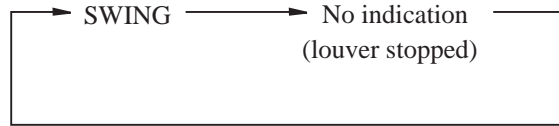

Change to the AIRFLOW mode.

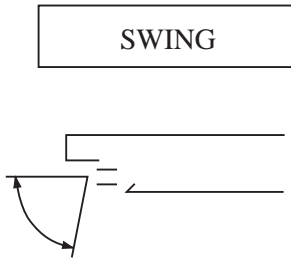

Louver moves in upward and downward directions continuously.



When the LOUVER button is pushed during SWING mode, it stops swinging at the just angle.

- Recommendable stopping angle of the louver

⚠ CAUTION

- Avoid direct air flow to the body for many hours.
- Avoid downward blowing operation of cooling mode for many hours.
- Do not touch the swing louver during swing operation.
- Please use the Swing button of remote controller. If adjusted by hand, it would cause an injure. (Only for 24,28,36,42 series.)

COOL and DRY	<p>(Horizontal Blowing)</p>
HEAT	<p>(Downward Blowing)</p>

■ GUIDE TO OPERATION

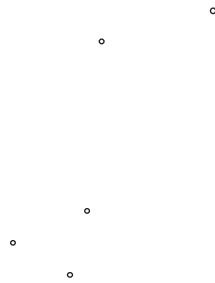

○ LOCK ○ RESET 

temperature is lower than the setting one which is to prevent from too hot to your sleep.

about 6 hrs
1 hr
1 hr

■ GUIDE TO OPERATION

Remote Control:

There is a telecommunication interface for remote control on the control panel of the indoor unit. After the peripheral equipment have been installed in accordance with the instruction manual of the selected remote control detector, the air conditioner will be computerized and controlled from a far-away place.

Power Failure Compensation (to be applied for a necessary situation) :

After the power failure compensation is set, if power failure suddenly occurs while the air conditioner is working, it will resume the previous working state when the power is supplied again.

Setting Method: When the remote controller is on (excluding timer mode and fan mode), press the "Sleeping" button on the remote controller 10 times within 5 seconds, and after the buzzer rings 4 times, the air conditioner will enter the state of power failure compensation.

Cancel Method: Press the "Sleeping" button on the remote controller 10 times within 5 seconds, and after the buzzer rings 2 timer, the power failure compensation mode will be cancelled.

Notes: When a power failure suddenly occurs during the air conditioner is working after the power failure compensation is set, if the air conditioner will not be used for a long time, please cut off the power supply to prevent its operation from being resumed after the power is supplied again, or press the "Switch On/Off" button after the power comes again.

■ CLEANING AND CARE

⚠ CAUTION!

- Before cleaning the air conditioner, be sure to turn it off and disconnect the Power Supply Cord.
- Be sure the Intake Grill is installed securely.
- When removing and replacing the air filters, be sure not to touch the heat exchanger, as personal injury may result.

Cleaning the Air Filter

(For Series 14,18)

Open the Intake Grill

1. Pull out both sides and the center of the Intake Grill.

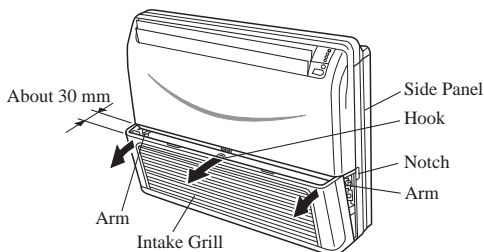

2. Pull the Air Filters upward to remove them.

Push the Air Filter handles away from the Intake Grille in direction as illustrated, then pull out Air Filters.

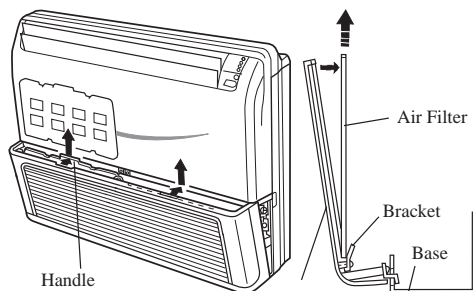

3. Clean the Air Filters.

Remove the dust from the Air Filters by vacuum cleaner or washing them. After washing, allow the Air Filters to dry thoroughly in an area protected from sunlight.

4. Re-attach the Air Filters to the Intake Grill.

- ① The Filters fit onto the inside of the intake Grill. (figure 1)
- ② The bottom edges of the Air Filters should fit into the filter brackets. (figure 1)
- ③ The Air Filters should be pushed down so that their top edges fit under the projections at the top of the Intake Grill. (figure 2)

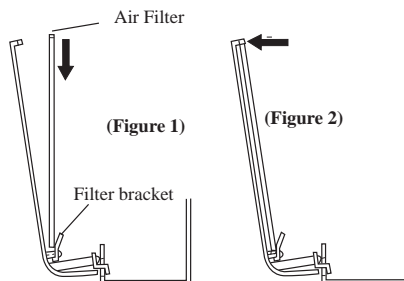

5. Push in both sides and the center of the Intake Grill.

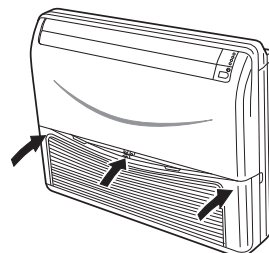

- Dust can be cleaned from the Air Filter either with a vacuum cleaner, or by washing the filter in a solution of mild detergent and warm water. If you wash the filter, be sure to allow it to dry thoroughly in a shady place before reinstalling.
- If dirt is allowed to accumulate on the Air Filter, air flow will be reduced, lowering operating efficiency and increasing noise.
- During periods of normal use, the Air Filters should be cleaned every two weeks.

■ CLEANING AND CARE

⚠ CAUTION!

- Before cleaning the air conditioner, be sure to turn it off and disconnect the Power Supply Cord.
- Be sure the Intake Grill is installed securely.
- When removing and replacing the air filters, be sure not to touch the heat exchanger, as personal injury may result.

The following four procedures are for series 24,28,36,42.

1. Press the two buttons on the filters, until you hear a sound of click.

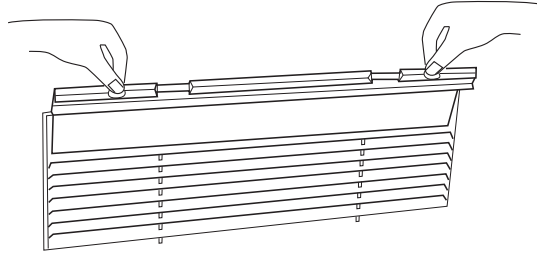

2. Pull the filters upward to remove them from the Intake Grill.

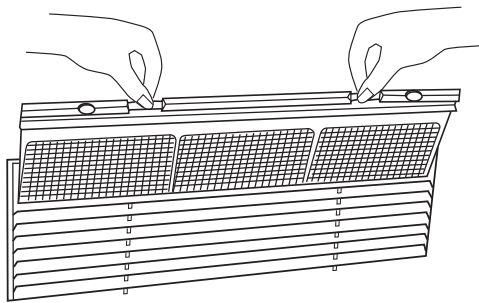





3. Clean the air filter: Remove the dust from the filters by vacuum cleaner or washing them. After washing, allow the air filters to dry thoroughly in an area protected from sunlight.

4. Re-attach the air filters to the Intake Grill, press the two buttons on the filters, until you hear a sound of click.

- When used for extended periods, the unit may accumulate dirt inside, which reduces its performance. We recommend that the unit is inspected regularly, in addition to your own cleaning and care. For more information, consult authorized service personnel.
- When cleaning the unit's body, do not use water hotter than 40°C, harsh abrasive cleansers, or volatile agents like benzene or thinner.
- Do not expose the unit body to liquid insecticides or hairsprays.
- When shutting down the unit for one month or more, first allow the Fan mode to operate continuously for about half a day to allow internal parts to dry thoroughly.





■ TROUBLE SHOOTING

Followings are not problems

<p>Sound of water flowing is not a problem.</p> 	<p>During unit operation or at stop, a swishing or gurgling noise may be heard. This noise is generated by refrigerant flowing in the system.</p>
<p>Sound of cracking is heard.</p>	<p>During unit operation, a cracking noise may be heard. This noise is generated by the casing expanding or shrinking because of temperature changes.</p>
<p>Smell are generated.</p>	<p>This is because the system circulates smells from the interior air such as the smell of cigarettes or the painting on the furniture.</p>
<p>During operation, white fog or steam comes out from the indoor unit.</p>	<p>When unit is running at places like restaurant, etc. where dense edible oil fumes always exist, this will happen.</p>
<p>In cooling operation, unit switches to blowing operation.</p>	<p>To prevent frost from accumulating on indoor heat exchanger, unit will switch to blowing operation for a while then resume cooling operation.</p>
<p>Unit will not restart after stop.</p> <p>Won't start?</p> 	<p>Though ON/OFF button is set to ON, unit won't resume cooling, dry or heating operation in 3 min after it is stopped, this is because of 3-min-delay protection circuit.</p>  <p>Please wait 3 minutes</p>
<p>No outlet air or fan speed can't be changed in dry mode.</p>	<p>Unit will reduce fan speed repeatedly and automatically if room temp. is too low in dry operation.</p>
<p>In heating operation, water or steam are blown out of outdoor unit.</p> 	<p>This occurs when frost accumulated on the outdoor unit is removed. (during defrosting operation)</p> 
<p>In heating operation, indoor fan won't stop even if unit is stopped.</p>	<p>After unit stop, indoor fan will go on running until indoor unit cools down.</p>

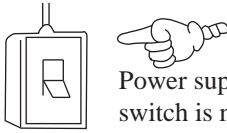
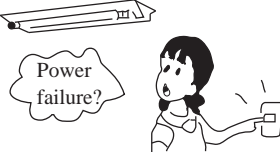
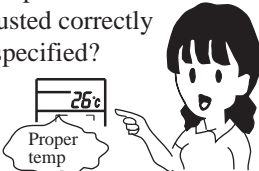
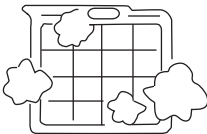
■ TROUBLE SHOOTING

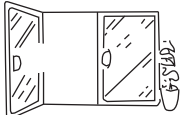
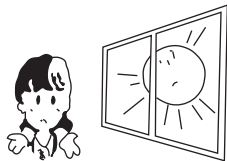
Before ask for services, please first check your unit against the following.

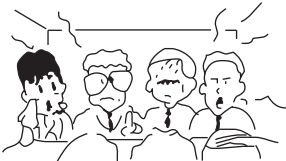
Air conditioner won't start.		
<p>Is power supply switch turned on?</p>  <p>Power supply switch is not set at ON.</p>	<p>Is city power supply normal?</p>  <p>Power failure?</p>	<p>Is leakage current breaker activated?</p> <p>This is very dangerous, please disconnect power supply immediately and contact your dealer.</p>
Poor cooling or heating		
<p>Are operation control adjusted correctly as specified?</p>  <p>Proper temp</p>	<p>Is air filter too dirty?</p> 	<p>Are there any obstacles in inlet or outlet grill?</p> 
<p>Are horizontal louvers at up position (in heating mode)?</p>	<p>Any doors or windows left open?</p> 	
Poor cooling		
<p>Is there any direct sunlight in the room?</p> 	<p>If there are unexpected heat sources in the room?</p> 	<p>Too many people in the room?</p> 
<p>Cold air blows out (in heating mode)</p>	<p>If your unit still can't work properly after above mentioned checks, or following problems occur, please stop it immediately and contact your dealer.</p> <ul style="list-style-type: none"> • Fuses or circuit breakers often blow out. • Water comes out in cooling/dry operation. • Operation is abnormal or sound is heard. 	
<p>Is air conditioner in standby condition in heating mode?</p>		

***Microcomputer-controlled Automatic Defrosting**

When performance is being produced, we recommend you use this air conditioner in conjunction with another kind of heating appliance.

Heat-pump air conditioners heat your entire room by recirculating air throughout the room, with the result that some time may be required after first starting the air conditioner until the room is heated.